

FEATURES

Very low distortion

0.00025% THD + N (20 kHz)

0.0015% THD + N (100 kHz)

Drives 600 Ω loads

Excellent gain accuracy

0.03% maximum gain error

2 ppm/°C maximum gain drift

Gain of ½ or 2

AC specifications

20 V/μs minimum slew rate

800 ns to 0.01% settling time

High accuracy dc performance

83 dB minimum CMRR

700 μV maximum offset voltage

8-lead SOIC and MSOP packages

Supply current: 2.6 mA maximum

Supply range: ±2.5 V to ±18 V

APPLICATIONS

ADC driver

High performance audio

Instrumentation amplifier building blocks

Level translators

Automatic test equipment

Sine/cosine encoders

GENERAL DESCRIPTION

The AD8274 is a difference amplifier that delivers excellent ac and dc performance. Built on Analog Devices, Inc., proprietary *iPolar*® process and laser-trimmed resistors, AD8274 achieves a breakthrough in distortion vs. current consumption and has excellent gain drift, gain accuracy, and CMRR.

Distortion in the audio band is an extremely low 0.00025% (112 dB) at a gain of ½ and 0.00035% (109 dB) at a gain of 2 while driving a 600 Ω load

With supply voltages up to ±18 V (+36 V single supply), the AD8274 is well suited for measuring large industrial signals. Additionally, the part's resistor divider architecture allows it to measure voltages beyond the supplies.

FUNCTIONAL BLOCK DIAGRAM

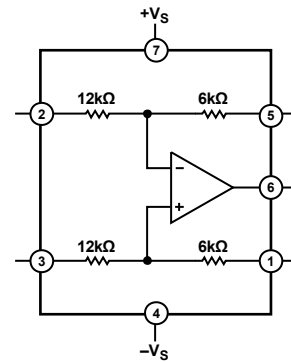

Figure 1.

Table 1. Difference Amplifiers by Category

Low Distortion	High Voltage	Single-Supply Unidirectional	Single-Supply Bidirectional
AD8270	AD628	AD8202	AD8205
AD8273	AD629	AD8203	AD8206
AD8274			AD8216
AMP03			

With no external components, the AD8274 can be configured as a $G = \frac{1}{2}$ or $G = 2$ difference amplifier. For single-ended applications that need high gain stability or low distortion performance, the AD8274 can also be configured for several gains ranging from -2 to $+3$.

The excellent distortion and dc performance of the AD8274, along with its high slew rate and bandwidth, make it an excellent ADC driver. Because of the part's high output drive, it also makes a very good cable driver.

The AD8274 only requires 2.6 mA maximum supply current. It is specified over the industrial temperature range of -40°C to $+85^{\circ}\text{C}$ and is fully RoHS compliant. For the dual version, see the [AD8273](#) data sheet.

Rev. A

Information furnished by Analog Devices is believed to be accurate and reliable. However, no responsibility is assumed by Analog Devices for its use, nor for any infringements of patents or other rights of third parties that may result from its use. Specifications subject to change without notice. No license is granted by implication or otherwise under any patent or patent rights of Analog Devices. Trademarks and registered trademarks are the property of their respective owners.

TABLE OF CONTENTS

Features	1	Pin Configurations and Function Description.....	5
Applications.....	1	Typical Performance Characteristics	6
Functional Block Diagram	1	Theory of Operation	12
General Description	1	Circuit Information.....	12
Revision History	2	Driving the AD8274.....	12
Specifications.....	3	Power Supplies.....	12
Absolute Maximum Ratings.....	4	Input Voltage Range.....	12
Thermal Resistance	4	Configurations.....	13
Maximum Power Dissipation	4	Driving Cabling	14
Short-Circuit Current	4	Outline Dimensions	15
ESD Caution.....	4	Ordering Guide	15

REVISION HISTORY

12/08—Rev. 0 to Rev. A	
Changes to Figure 8 and Figure 10.....	6
7/08—Revision 0: Initial Version	

SPECIFICATIONS

$V_S = \pm 15\text{ V}$, $V_{REF} = 0\text{ V}$, $T_A = 25^\circ\text{C}$, $R_L = 2\text{ k}\Omega$, unless otherwise noted.

Table 2.

Parameter	Conditions	G = ½			G = 2			Unit
		Min	Typ	Max	Min	Typ	Max	
DYNAMIC PERFORMANCE								
Bandwidth			20		10			MHz
Slew Rate		20			20			V/ μs
Settling Time to 0.1%	10 V step on output, $C_L = 100\text{ pF}$		650	750		675	775	ns
Settling Time to 0.01%	10 V step on output, $C_L = 100\text{ pF}$		725	800		750	825	ns
NOISE/DISTORTION ¹								
THD + Noise	$f = 1\text{ kHz}$, $V_{OUT} = 10\text{ V p-p}$, 600 Ω load		0.00025		0.00035			%
Noise Floor, RTO ²	20 kHz BW		-106		-100			dBu
Output Voltage Noise (Referred to Output)	$f = 20\text{ Hz to } 20\text{ kHz}$		3.5		7			$\mu\text{V rms}$
	$f = 1\text{ kHz}$		26		52			nV/ $\sqrt{\text{Hz}}$
GAIN								
Gain Error				0.03			0.03	%
Gain Drift	$-40^\circ\text{C to } +85^\circ\text{C}$		0.5	2	0.5	2		ppm/ $^\circ\text{C}$
Gain Nonlinearity	$V_{OUT} = 10\text{ V p-p}$, 600 Ω load		2		2			ppm
INPUT CHARACTERISTICS								
Offset ³	Referred to output		150	700	300	1100		μV
vs. Temperature	$-40^\circ\text{C to } +85^\circ\text{C}$		3		6			$\mu\text{V}/^\circ\text{C}$
vs. Power Supply	$V_S = \pm 2.5\text{ V to } \pm 18\text{ V}$			5		10		$\mu\text{V/V}$
Common-Mode Rejection Ratio	$V_{CM} = \pm 40\text{ V}$, $R_S = 0\ \Omega$, referred to input	77	86		83	92		dB
Input Voltage Range ⁴		$-3V_S$ + 4.5		$+3V_S$ - 4.5	$-1.5V_S$ + 2.3		$+1.5V_S$ - 2.3	V
Impedance ⁵								
Differential	$V_{CM} = 0\text{ V}$		24		12			k Ω
Common Mode ⁶			9		9			k Ω
OUTPUT CHARACTERISTICS								
Output Swing		$-V_S + 1.5$		$+V_S - 1.5$	$-V_S + 1.5$		$+V_S - 1.5$	V
Short-Circuit Current Limit	Sourcing		90		90			mA
	Sinking		60		60			mA
Capacitive Load Drive			200		1200			pF
POWER SUPPLY								
Supply Current (per Amplifier)			2.3	2.6	2.3	2.6		mA
TEMPERATURE RANGE								
Specified Performance		-40		+85	-40		+85	$^\circ\text{C}$

¹ Includes amplifier voltage and current noise, as well as noise of internal resistors.

² dBu = $20 \log(V_{\text{rms}}/0.7746)$.

³ Includes input bias and offset current errors.

⁴ May also be limited by absolute maximum input voltage or by the output swing. See the Absolute Maximum Ratings section and Figure 8 through Figure 11 for details.

⁵ Internal resistors are trimmed to be ratio matched but to have $\pm 20\%$ absolute accuracy.

⁶ Common mode is calculated by looking into both inputs. The common-mode impedance at only one input is 18 k Ω .

ABSOLUTE MAXIMUM RATINGS

Table 3.

Parameter	Rating
Supply Voltage	$\pm 18\text{ V}$
Maximum Voltage at Any Input Pin	$-V_S + 40\text{ V}$
Minimum Voltage at Any Input Pin	$+V_S - 40\text{ V}$
Storage Temperature Range	-65°C to $+150^\circ\text{C}$
Specified Temperature Range	-40°C to $+85^\circ\text{C}$
Package Glass Transition Temperature (T_G)	150°C

Stresses above those listed under Absolute Maximum Ratings may cause permanent damage to the device. This is a stress rating only; functional operation of the device at these or any other conditions above those indicated in the operational section of this specification is not implied. Exposure to absolute maximum rating conditions for extended periods may affect device reliability.

THERMAL RESISTANCE

The θ_{JA} values in Table 4 assume a 4-layer JEDEC standard board with zero airflow.

Table 4. Thermal Resistance

Package Type	θ_{JA}	Unit
8-Lead MSOP	135	$^\circ\text{C}/\text{W}$
8-Lead SOIC	121	$^\circ\text{C}/\text{W}$

MAXIMUM POWER DISSIPATION

The maximum safe power dissipation for the AD8274 is limited by the associated rise in junction temperature (T_J) on the die. At approximately 150°C , which is the glass transition temperature, the properties of the plastic change. Even temporarily exceeding this temperature limit may change the stresses that the package exerts on the die, permanently shifting the parametric performance of the amplifiers. Exceeding a temperature of 150°C for an extended period may result in a loss of functionality.

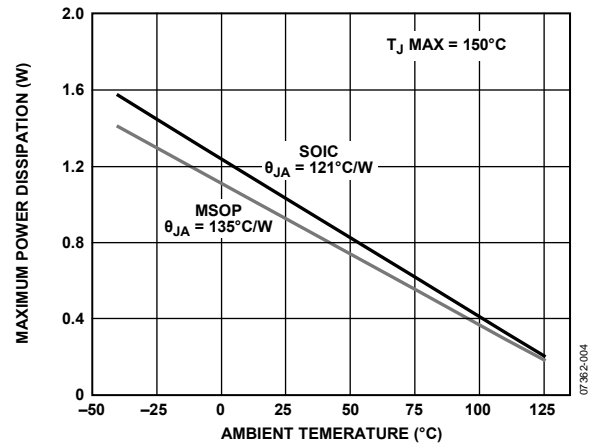

Figure 2. Maximum Power Dissipation vs. Ambient Temperature

SHORT-CIRCUIT CURRENT

The AD8274 has built-in, short-circuit protection that limits the output current (see Figure 16 for more information). While the short-circuit condition itself does not damage the part, the heat generated by the condition can cause the part to exceed its maximum junction temperature, with corresponding negative effects on reliability. Figure 2 and Figure 16, combined with knowledge of the part's supply voltages and ambient temperature, can be used to determine whether a short circuit will cause the part to exceed its maximum junction temperature.

ESD CAUTION



ESD (electrostatic discharge) sensitive device.

Charged devices and circuit boards can discharge without detection. Although this product features patented or proprietary protection circuitry, damage may occur on devices subjected to high energy ESD. Therefore, proper ESD precautions should be taken to avoid performance degradation or loss of functionality.

PIN CONFIGURATIONS AND FUNCTION DESCRIPTION

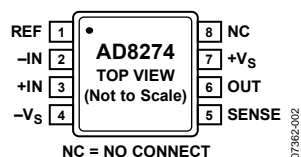

Figure 3. MSOP Pin Configuration

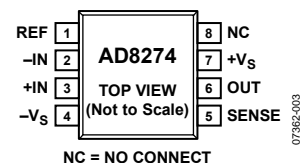

Figure 4. SOIC Pin Configuration

Table 5. Pin Function Descriptions

Pin No.	Mnemonic	Description
1	REF	6 k Ω Resistor to Noninverting Terminal of Op Amp. Used as reference pin in $G = \frac{1}{2}$ configuration. Used as positive input in $G = 2$ configuration.
2	-IN	12 k Ω Resistor to Inverting Terminal of Op Amp. Used as negative input in $G = \frac{1}{2}$ configuration. Connect to output in $G = 2$ configuration.
3	+IN	12 k Ω Resistor to Noninverting Terminal of Op Amp. Used as positive input in $G = \frac{1}{2}$ configuration. Used as reference pin in $G = 2$ configuration.
4	-Vs	Negative Supply.
5	SENSE	6 k Ω Resistor to Inverting Terminal of Op Amp. Connect to output in $G = \frac{1}{2}$ configuration. Used as negative input in $G = 2$ configuration.
6	OUT	Output.
7	+Vs	Positive Supply.
8	NC	No Connect.

TYPICAL PERFORMANCE CHARACTERISTICS

$V_S = \pm 15\text{ V}$, $T_A = 25^\circ\text{C}$, gain = $\frac{1}{2}$, difference amplifier configuration, unless otherwise noted.

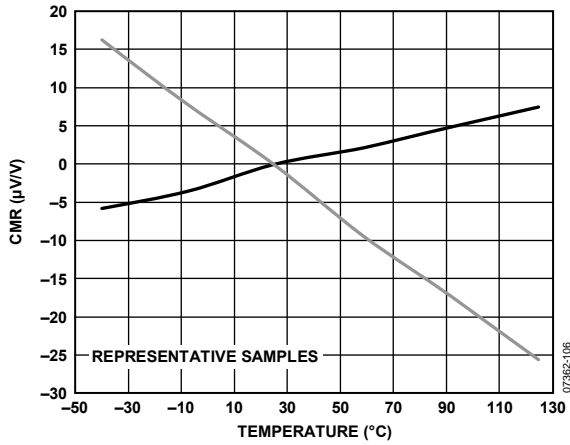

Figure 5. CMR vs. Temperature, Normalized at 25°C, Gain = $\frac{1}{2}$

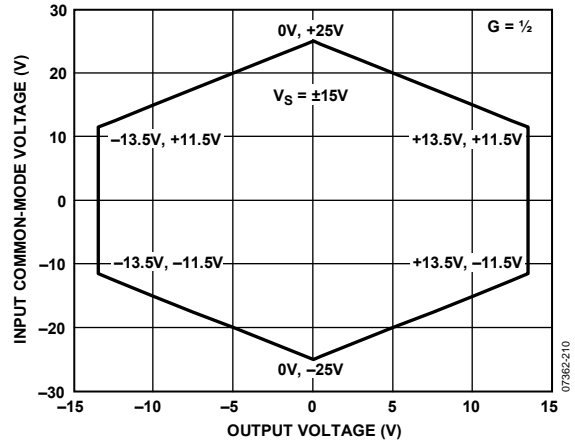

Figure 8. Input Common-Mode Voltage vs. Output Voltage, Gain = $\frac{1}{2}$, $\pm 15\text{ V}$ Supplies

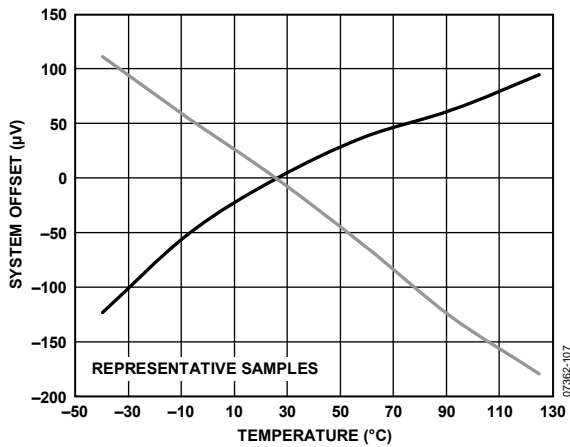

Figure 6. System Offset vs. Temperature, Normalized at 25°C, Referred to Output, Gain = $\frac{1}{2}$

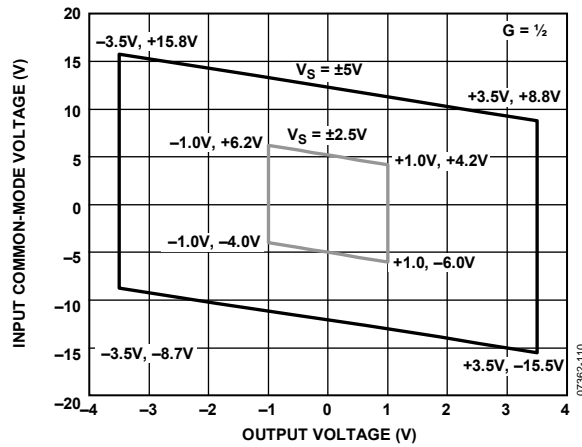

Figure 9. Input Common-Mode Voltage vs. Output Voltage, Gain = $\frac{1}{2}$, $\pm 5\text{ V}$ and $\pm 2.5\text{ V}$ Supplies

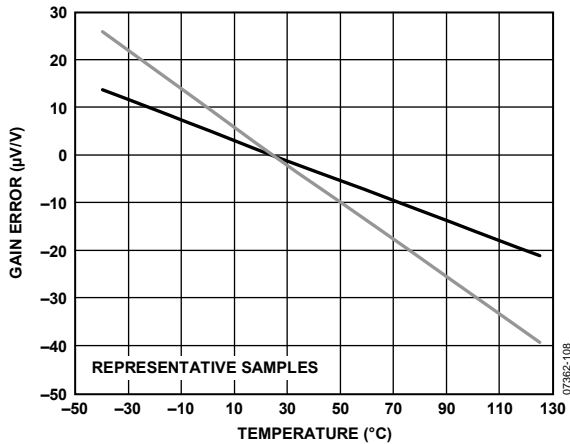

Figure 7. Gain Error vs. Temperature, Normalized at 25°C, Gain = $\frac{1}{2}$

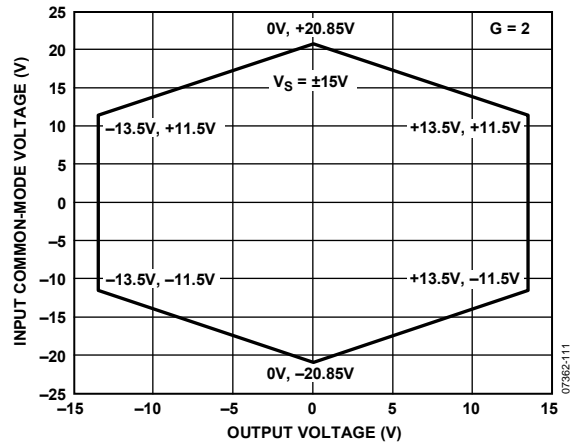

Figure 10. Input Common-Mode Voltage vs. Output Voltage, Gain = 2, $\pm 15\text{ V}$ Supplies

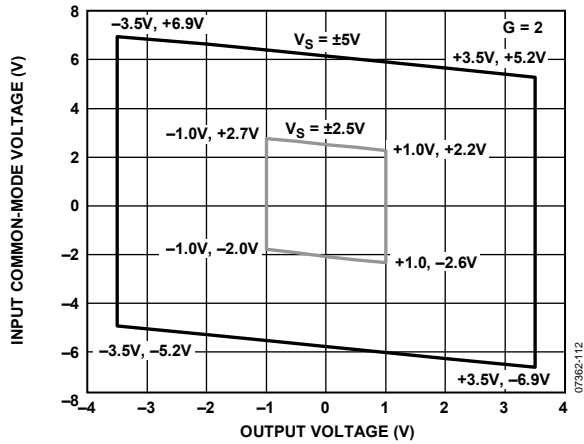

Figure 11. Input Common-Mode Voltage vs. Output Voltage, Gain = 2, ±5 V and ±2.5 V Supplies

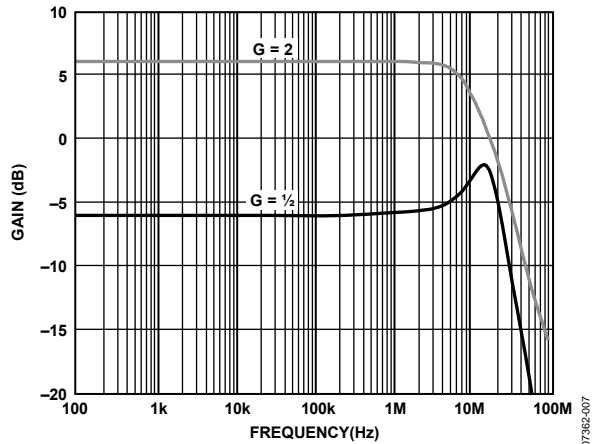

Figure 14. Gain vs. Frequency

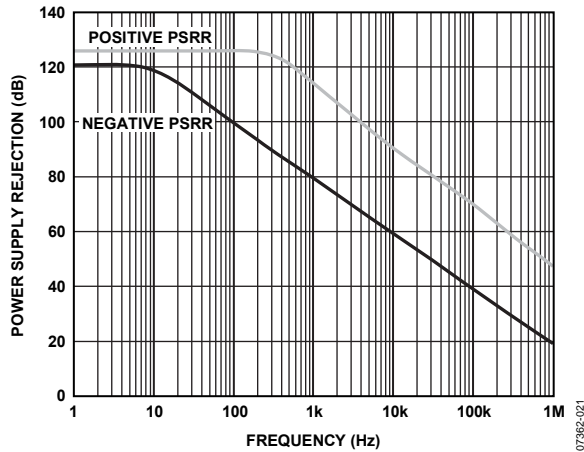

Figure 12. Power Supply Rejection Ratio vs. Frequency, Gain = 1/2, Referred to Output

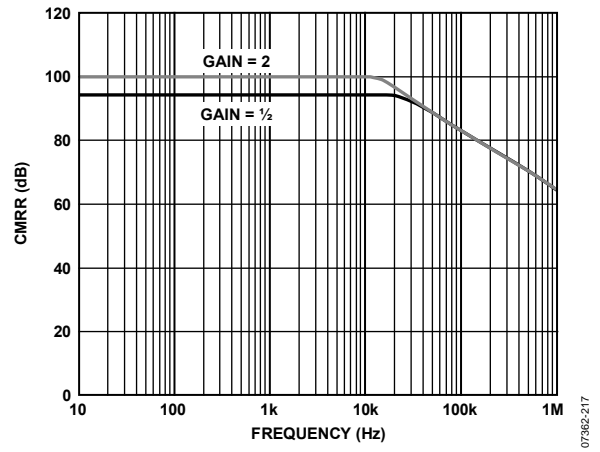

Figure 15. Common-Mode Rejection Ratio vs. Frequency, Referred to Input

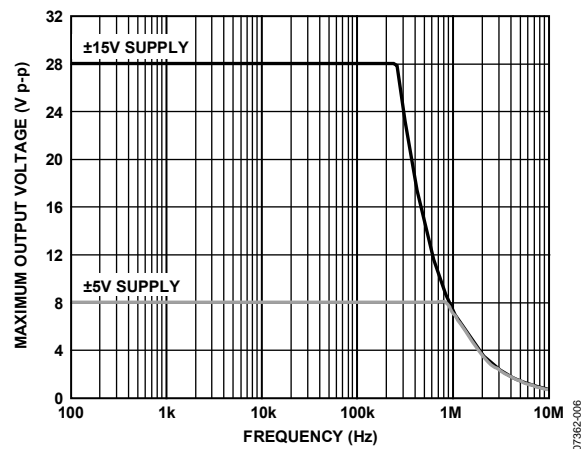

Figure 13. Maximum Output Voltage vs. Frequency

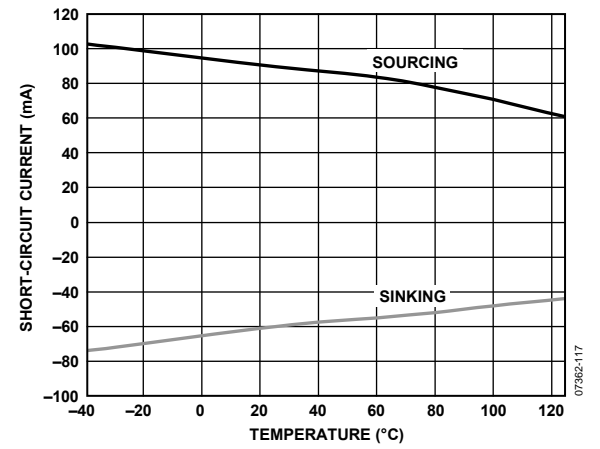

Figure 16. Short-Circuit Current vs. Temperature

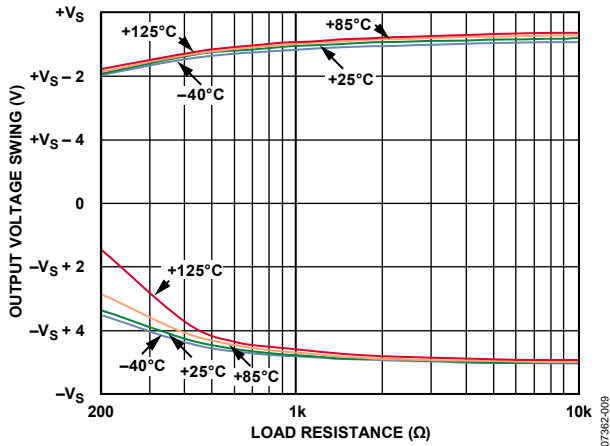

Figure 17. Output Voltage Swing vs. R_L , $V_S = \pm 15\text{ V}$

07982-009

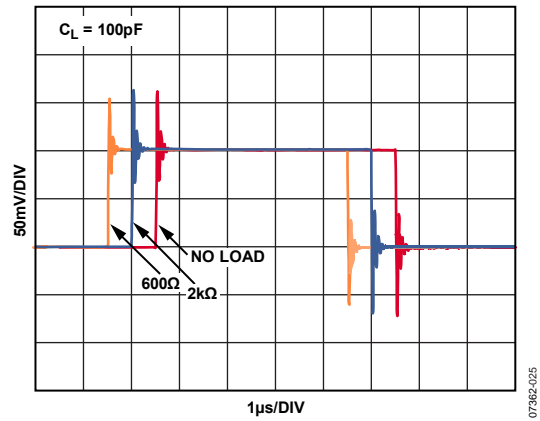

Figure 20. Small-Signal Step Response, Gain = $\frac{1}{2}$

07982-025

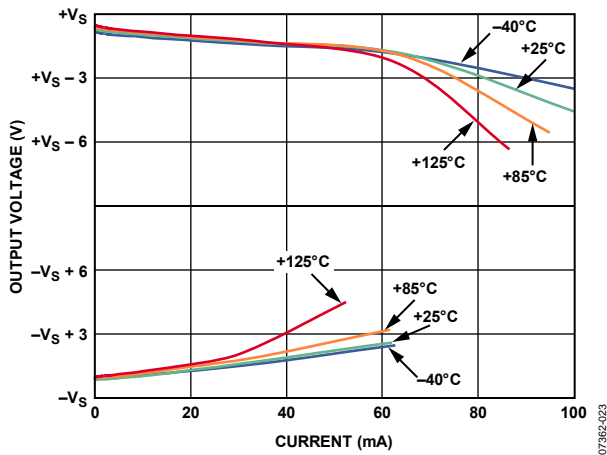

Figure 18. Output Voltage vs. I_{OUT}

07982-023

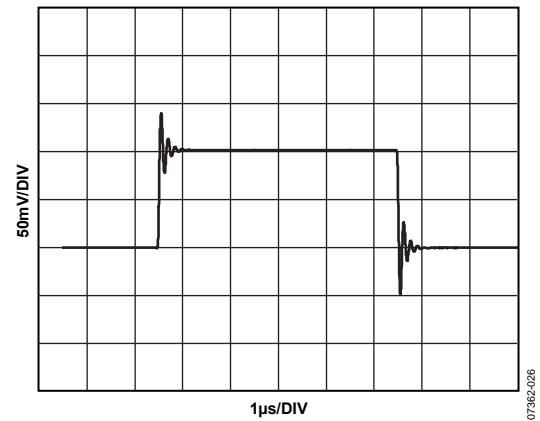

Figure 21. Small-Signal Pulse Response with 500 pF Capacitor Load, Gain = 2

07982-026

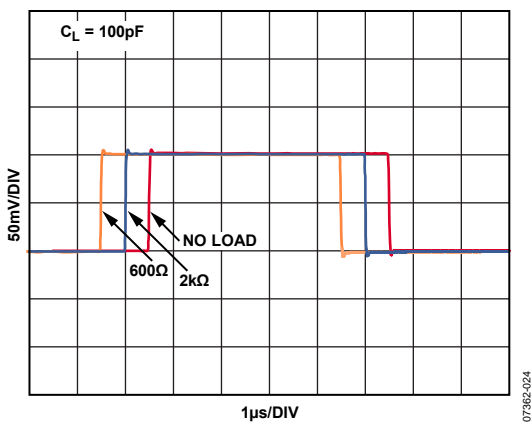

Figure 19. Small-Signal Step Response, Gain = 2

07982-024

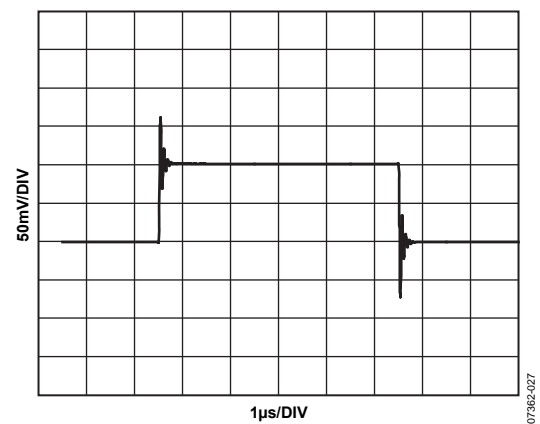

Figure 22. Small-Signal Pulse Response for 100 pF Capacitive Load, Gain = $\frac{1}{2}$

07982-027

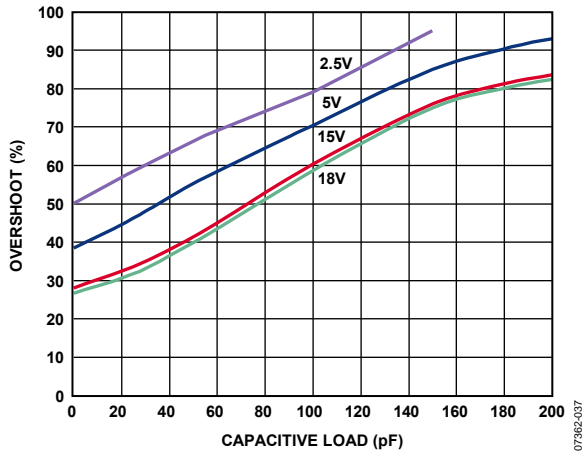

Figure 23. Small-Signal Overshoot vs. Capacitive Load, Gain = 1/2, No Resistive Load

07362-037

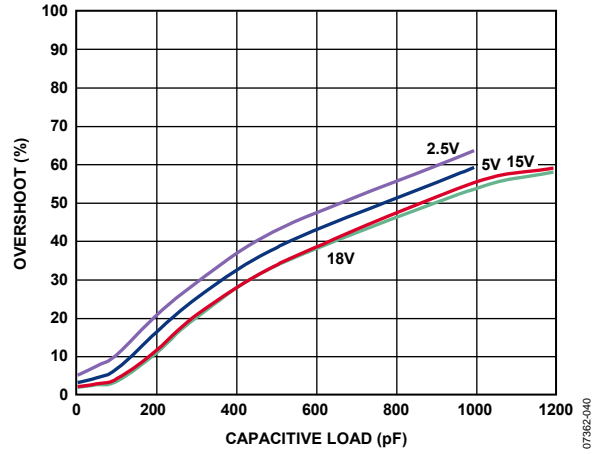

Figure 26. Small-Signal Overshoot vs. Capacitive Load, Gain = 2, 600 Ω in Parallel with Capacitive Load

07362-040

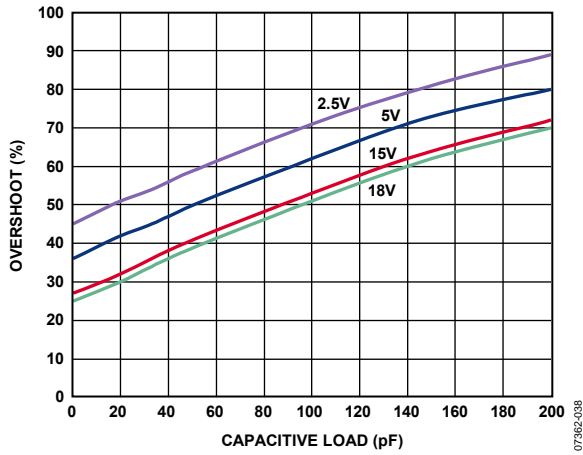

Figure 24. Small-Signal Overshoot vs. Capacitive Load, Gain = 1/2, 600 Ω in Parallel with Capacitive Load

07362-038

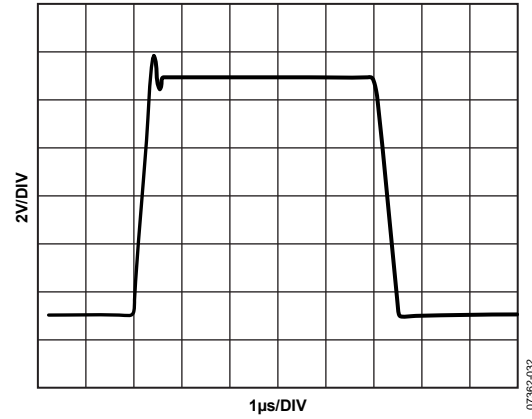

Figure 27. Large-Signal Pulse Response, Gain = 1/2

07362-032

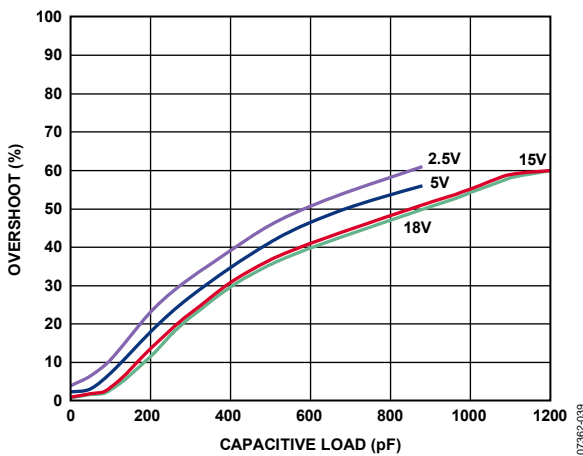

Figure 25. Small-Signal Overshoot vs. Capacitive Load, Gain = 2, No Resistive Load

07362-039

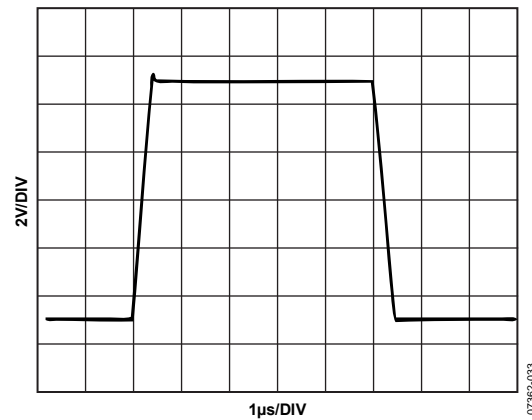

Figure 28. Large-Signal Pulse Response, Gain = 2

07362-033

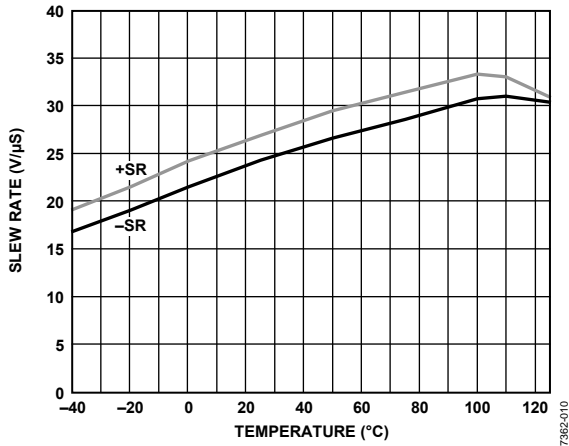

Figure 29. Slew Rate vs. Temperature

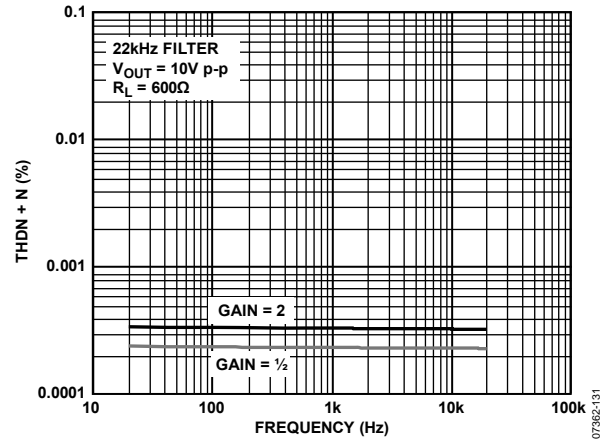

Figure 32. THD + N vs. Frequency, Filter = 22k Hz

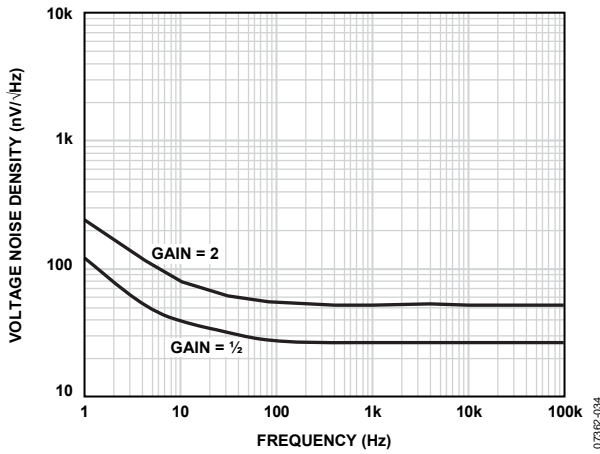

Figure 30. Voltage Noise Density vs. Frequency, Referred to Output

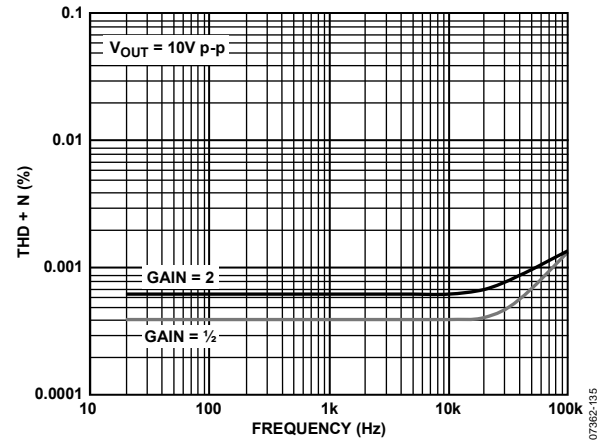

Figure 33. THD + N vs. Frequency, Filter = 120 kHz

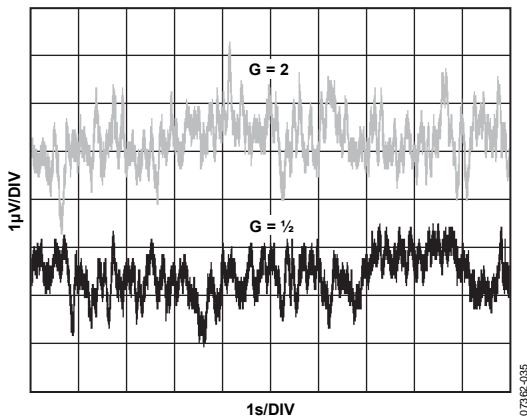

Figure 31. 0.1 Hz to 10 Hz Voltage Noise, RTO

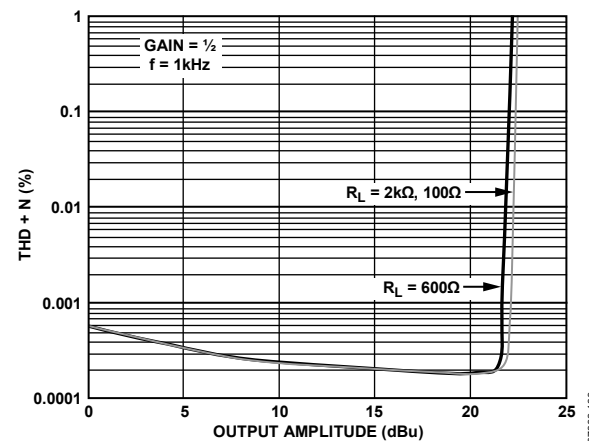

Figure 34. THD + N vs. Output Amplitude, G = 1/2

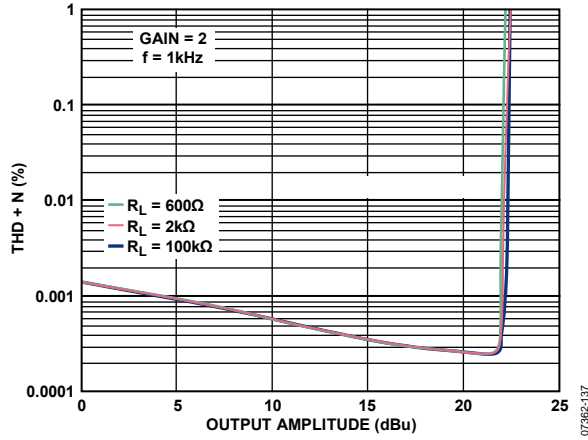

Figure 35. THD + N vs. Output Amplitude, G = 2

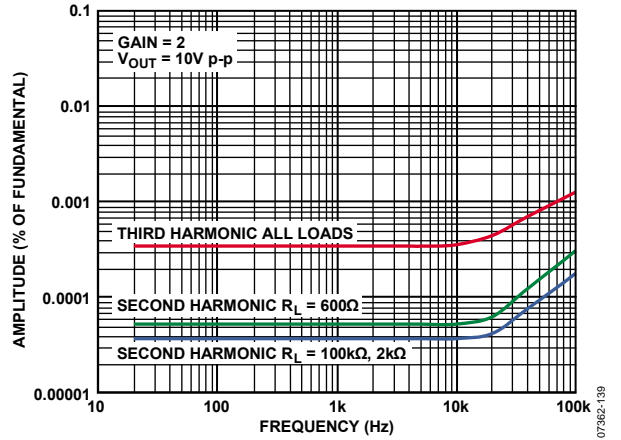

Figure 37. Harmonic Distortion Products vs. Frequency, G = 2

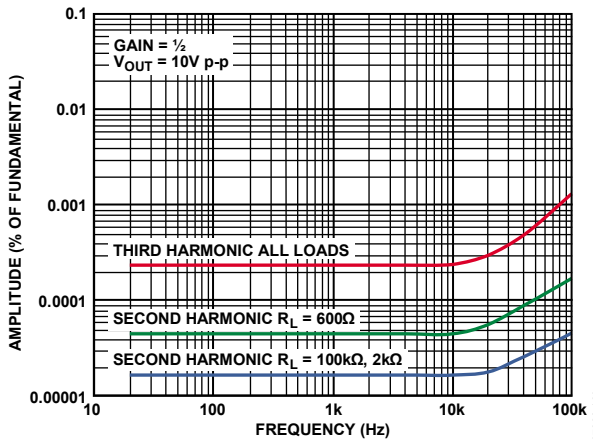

Figure 36. Harmonic Distortion Products vs. Frequency, G = 1/2

THEORY OF OPERATION

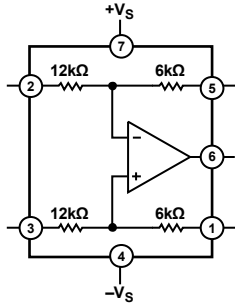

Figure 38. Functional Block Diagram

CIRCUIT INFORMATION

The AD8274 consists of a high precision, low distortion op amp and four trimmed resistors. These resistors can be connected to make a wide variety of amplifier configurations, including difference, noninverting, and inverting configurations. Using the on-chip resistors of the AD8274 provides the designer with several advantages over a discrete design.

DC Performance

Much of the dc performance of op amp circuits depends on the accuracy of the surrounding resistors. The resistors on the AD8274 are laid out to be tightly matched. The resistors of each part are laser trimmed and tested for their matching accuracy. Because of this trimming and testing, the AD8274 can guarantee high accuracy for specifications such as gain drift, common-mode rejection, and gain error.

AC Performance

Because feature size is much smaller in an integrated circuit than on a printed circuit board (PCB), the corresponding parasitics are also smaller. The smaller feature size helps the ac performance of the AD8274. For example, the positive and negative input terminals of the AD8274 op amp are not pinned out intentionally. By not connecting these nodes to the traces on the PCB, the capacitance remains low, resulting in both improved loop stability and common-mode rejection over frequency.

Production Costs

Because one part, rather than several, is placed on the PCB, the board can be built more quickly.

Size

The AD8274 fits a precision op amp and four resistors in one 8-lead MSOP or SOIC package.

DRIVING THE AD8274

The AD8274 is easy to drive, with all configurations presenting at least several kilohms (kΩ) of input resistance. The AD8274 should be driven with a low impedance source: for example, another amplifier. The gain accuracy and common-mode rejection of the AD8274 depend on the matching of its resistors. Even source resistance of a few ohms can have a substantial effect on these specifications.

POWER SUPPLIES

A stable dc voltage should be used to power the AD8274. Noise on the supply pins can adversely affect performance. A bypass capacitor of 0.1 μF should be placed between each supply pin and ground, as close as possible to each supply pin. A tantalum capacitor of 10 μF should also be used between each supply and ground. It can be farther away from the supply pins and, typically, it can be shared by other precision integrated circuits.

The AD8274 is specified at ±15 V, but it can be used with unbalanced supplies, as well. For example, $-V_S = 0$ V, $+V_S = 20$ V. The difference between the two supplies must be kept below 36 V.

INPUT VOLTAGE RANGE

The AD8274 can measure voltages beyond the rails. For the $G = 1/2$ and $G = 2$ difference amplifier configurations, see the input voltage range in Table 2 for specifications.

The AD8274 is able to measure beyond the rail because the internal resistors divide down the voltage before it reaches the internal op amp. Figure 39 shows an example of how the voltage division works in the difference amplifier configuration. For the AD8274 to measure correctly, the input voltages at the internal op amp must stay within 1.5 V of either supply rail.

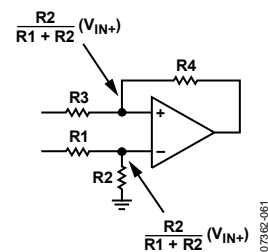

Figure 39. Voltage Division in the Difference Amplifier Configuration

For best long-term reliability of the part, voltages at any of the part's inputs (Pin 1, Pin 2, Pin 3, or Pin 5) should stay within $+V_S - 40$ V to $-V_S + 40$ V. For example, on ±10 V supplies, input voltages should not exceed ±30 V.

CONFIGURATIONS

The AD8274 can be configured in several ways; see Figure 40 to Figure 47. Because these configurations rely on the internal, matched resistors, all of these configurations have excellent gain accuracy and gain drift. Note that the AD8274 internal op amp is stable for noise gains of 1.5 and higher, so the AD8274 should not be placed in a unity-gain follower configuration.

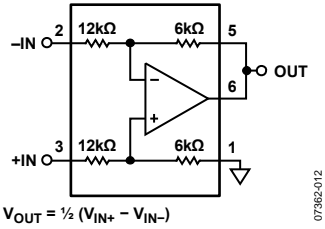

Figure 40. Difference Amplifier, $G = \frac{1}{2}$

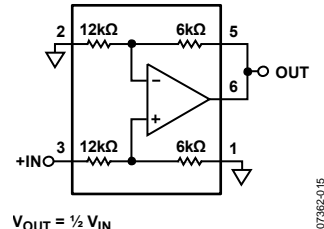

Figure 44. Noninverting Amplifier, $G = \frac{1}{2}$

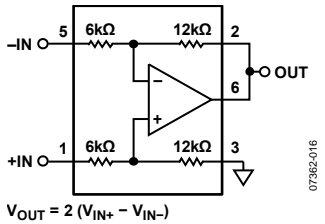

Figure 41. Difference Amplifier, $G = 2$

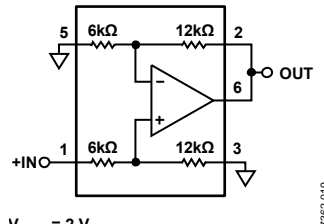

Figure 45. Noninverting Amplifier, $G = 2$

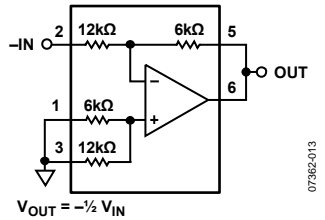

Figure 42. Inverting Amplifier, $G = -\frac{1}{2}$

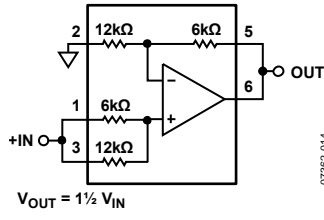

Figure 46. Noninverting Amplifier, $G = 1.5$

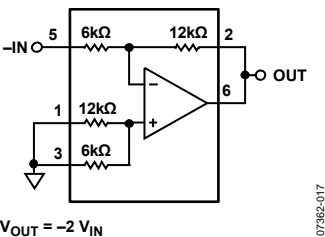

Figure 43. Inverting Amplifier, $G = -2$

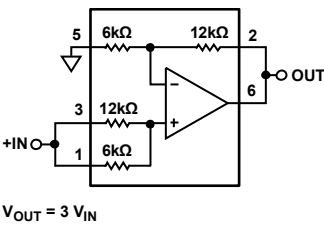

Figure 47. Noninverting Amplifier, $G = 3$

AD8274

DRIVING CABLING

Because the AD8274 can drive large voltages at high output currents and slew rates, it makes an excellent cable driver. It is good practice to put a small value resistor between the AD8274 output and cable, since capacitance in the cable can cause peaking or instability in the output response. A resistance of $20\ \Omega$ or higher is recommended.

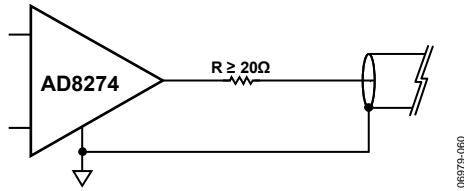
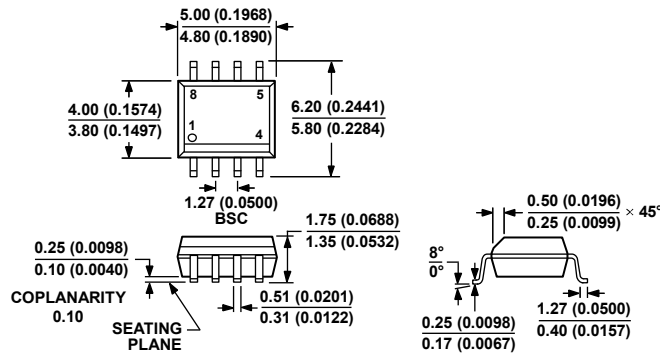

Figure 48. Driving Cabling

06879-060

OUTLINE DIMENSIONS



COMPLIANT TO JEDEC STANDARDS MS-012-AA
 CONTROLLING DIMENSIONS ARE IN MILLIMETERS; INCH DIMENSIONS
 (IN PARENTHESES) ARE ROUNDED-OFF MILLIMETER EQUIVALENTS FOR
 REFERENCE ONLY AND ARE NOT APPROPRIATE FOR USE IN DESIGN.

012407-A

Figure 49. 8-Lead Standard Small Outline Package [SOIC_N]
 Narrow Body (R-8)
 Dimensions shown in millimeters and (inches)

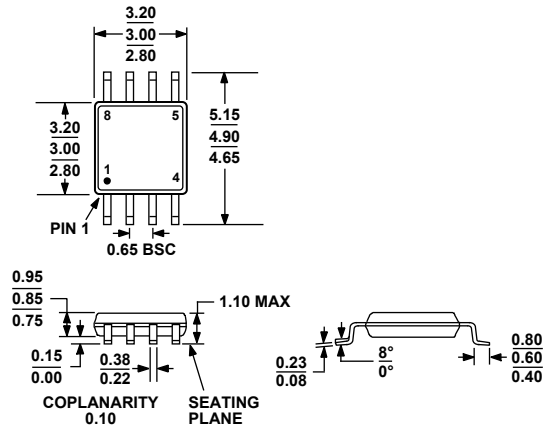

COMPLIANT TO JEDEC STANDARDS MO-187-AA

Figure 50. 8-Lead Mini Small Outline Package [MSOP]
 (RM-8)
 Dimensions shown in millimeters

ORDERING GUIDE

Model	Temperature Range	Package Description	Package Option	Branding
AD8274ARZ ¹	-40°C to +85°C	8-Lead SOIC_N	R-8	
AD8274ARZ-R7 ¹	-40°C to +85°C	8-Lead SOIC_N, 7" Tape and Reel	R-8	
AD8274ARZ-RL ¹	-40°C to +85°C	8-Lead SOIC_N, 13" Tape and Reel	R-8	
AD8274ARMZ ¹	-40°C to +85°C	8-Lead MSOP	RM-8	Y1B
AD8274ARMZ-R7 ¹	-40°C to +85°C	8-Lead MSOP, 7" Tape and Reel	RM-8	Y1B
AD8274ARMZ-RL ¹	-40°C to +85°C	8-Lead MSOP, 13" Tape and Reel	RM-8	Y1B

¹ Z = RoHS Compliant Part.

AD8274

NOTES